



---

IIW/IIS - DOCUMENT XIII - 1964 - 03

**Comparison of the Improvement in Corrosion Fatigue Strength of  
Weld Repaired Marine Cu 3-grade Bronze Propellers by Ultrasonic  
Impact Treatment (UIT) or Heat Treatment**

**E.S. Statnikov, V.O. Muktepavel, V.N. Vityazev**

Applied Ultrasonics, P.O. Box 100422, Birmingham, Alabama, 35210, USA

Northern Scientific & Technology Company, NSTC  
6 Voronin St., Severodvinsk, Archangelsk Region, 164500, Russia

**V.I. Trufyakov, V.S. Kovalchuk**

The E.O. Paton Electric Welding Institute  
11 Bozhenko St., Kiev, 252650, Ukraine

**P.J. Haagenzen**

Norwegian University of Science and Technology, NTNU  
R. Birkelandsvei 1A, N-7491 Trondheim, Norway

**ABSTRACT**

Corrosion fatigue resistance is of great importance in the operation of marine propellers. Propeller castings, as a rule, are made using different casting methods characterized by the formation of various cast defects. Rectification of defective castings involves removal of the defects followed by weld repair. Weld metal structure and residual welding stresses result in a decrease in the corrosion fatigue strength of the propeller.

In order to increase the corrosion fatigue strength in the weld repaired areas, qualification societies, such as Det Norske Veritas, Bureau Veritas, Germanischer Lloyd, Lloyd's Register of Shipping and Russian Maritime Register, require that weld-repaired propellers are heat treated. This technique is energy- and time-consuming as well as costly.

The paper presents the results of an investigation of the application UIT as an alternative to heat treatment based on comparative corrosion fatigue tests of plate specimens made from the same material as that used for propellers, bronze Cu 3.

It is shown that with UIT application during weld repair the corrosion fatigue strength is higher than that of heat treated propellers.

**Key words:** Propellers, corrosion fatigue strength, bronze, defects, deposition, welding, heat treatment, ultrasonic impact treatment.

## 1. INTRODUCTION. BACKGROUND

When a propeller is manufactured, the casting defects are revealed which are repaired by welding. Weld metal structure and residual welding stresses result in a decrease in the corrosion fatigue strength of the weld repaired area as compared with the base metal. According to the regulations of classification societies, such as Veritas, Lloyds, National Registers of Shipping, heat treatment (HT) is performed to increase (restore) the corrosion fatigue strength by relief of tensile residual stress and to obtain an equilibrium metal structure.

Heat treatment of marine propellers is a costly and long-term operation. Creation of a post-weld method for improving the corrosion fatigue strength of welds that would allow heat treatment to be omitted is a topical problem in the manufacture of propellers.

The objectives of this work were to develop such a method, to evaluate its effectiveness and support the application of the method to be appropriate and sound for repairing casting defects by welding in propellers made from copper alloys (Cu 3).

Applied Ultrasonics (AU, USA) and Northern Scientific and Technology Company (NSTC, Russia) have developed a method of UIT of propellers and the following analyses have been performed:

- analysis of the properties and quality of the base metal and a welded joint before and after UIT treatment;
- analysis of the corrosion fatigue characteristics of the large-scale base-metal specimens and specimens with weld deposits treated by either heat treatment or UIT.

NSTC and AU have developed the ultrasonic impact treatment (UIT) technology, Esonix [1,2,3], that, along with inducing compressive stresses to the surface layer of the treated material, makes possible distributing and relaxation of residual stresses, such as welding residual stresses. A special feature of this work is the application of a multifrequency UIT technique with carrier frequency of 27kHz. The power and the repetition rate of ultrasonic impacts are determined by the treatment procedure.

On this basis, Federal State Unitary Enterprise “ME Zvyozdochka” (FSUE “ME Zvyozdochka”) entered into a development agreement with NSTC.

Applied Ultrasonics provided the initial and current financing of these works between 1998 and 2000.

Prof. Per J. Haagenen of Norwegian University of Science and Technology, expert of Det Norske Veritas, has directly participated in the development of the work program under the agreement and made a proposal regarding the method and a structure of full-scale specimens for comparative testing [4, 5].

Zvyozdochka supplied the specimens and performed welding, weld deposition, mechanical operation, mechanical tests and metallographic testing of welded specimens.

NSTC have developed a work program, determined a test specimen fabrication technique, manufactured the UIT equipment and a tool, developed a UIT technique and performed UIT on specimens. In collaboration with subcontractors NSTC carried out the scheduled and additional tests.

The E.O. Paton Electric Welding Institute with regard to proposals of Prof. Per J. Haagensen have developed a procedure for corrosion fatigue testing large-scale specimens and performed testing [6].

The following metal-physical analyses were performed:

- mechanical and metallographic tests of welded specimens – Central Laboratory of Zvyozdochka, Severodvinsk;
- analysis of mechanical stresses in the surface layers of specimens – Material Analysis Laboratory of Northern Engineering Enterprise SEVMASH, Severodvinsk;
- analysis of the UIT effect on etching of the specimen surface and analysis of the untreated and UIT treated material characteristics in depth – Metallographic Laboratory of Sevmash, Severodvinsk;
- hardness measurement – Mechanical Test Laboratory of Sevmash, Severodvinsk.

It is shown that UIT, after weld repair, allows the casting defects on propellers in copper alloys (Cu-3) to be rectified, omitting heat treatment.

## 2. STATUS OF THE ISSUE

In compliance with Industrial Guideline “Propellers made from copper-based alloys. Rectification of defects and damages. Standard Manufacturing Process” and regulations specified by foreign classification societies (Det Norske Veritas, Lloyd’s Register of Shipping, Germanischer Lloyd), propellers are made from brasses and bronzes. Chemical composition and mechanical properties of Russian and foreign brasses and bronzes are almost the same. According to all above mentioned documents, the techniques of propeller production and defect rectification by welding, weld deposition and subsequent heat treatment are identical.

In compliance with western classification, Russian brass of LZn40Mn3Fe grade is similar to manganese bronze Cu 1; BrAl9Fe4Ni4 grade bronze is similar to Ni-aluminum bronze Cu 3; BrAl7Mn14Fe3Ni2 grade bronze is similar to Mn-aluminum bronze Cu 4. The Ni-manganese bronze Cu 2 is also used in the West.

According to Russian and foreign classification, the surfaces of propeller blades and hub are divided into three zones, A, B and C.

Propeller machining reveals casting defects that need to be repaired through grinding and arc welding. In quite a large number of cases where welding is applied (especially in zone B and, in specified cases, in zone A), subsequent general heat treatment of the entire propeller or local heat treatment of weld deposit areas is required.

Heat treatment of propellers is performed to relieve tensile residual stresses and to secure a comparatively equilibrium structure. Propellers made from Cu 3-grade bronze are heat treated following defect repair by welding on pressure side of blades at a distance of  $0,7R$ , where  $R$  is the radius of the propeller.

According to Det Norske Veritas, propellers made from brasses Cu 1, Cu 2 and bronze Cu 4 are sensitive to stress corrosion cracking. In order to relieve stresses, it is essential to subject the repaired area coming in contact with sea water to heat treatment. Bronze Cu 3 is virtually

unsusceptible to stress corrosion cracking. Welding stress relief tempering is not performed on this bronze.

According to Lloyd's Register of Shipping, weld deposits on solid propeller surfaces and separately cast blades should be subjected to stress-relieving heat treatment. In this case, heat treatment is optional in zone C of blades and for hub of fixed pitch propellers made of bronze Cu 3.

According to Germanischer Lloyd, weld deposits on propellers of all types, excluding propellers made of Cu 3 alloy, should be heat treated for stress relief and prevention of corrosion cracking. Heat treatment may as well be necessary for Cu 3 alloy provided that the major repair requires weld deposition in zones B and A.

Thus, welding stress relief heat treatment is often an indispensable operation for propellers in copper alloys.

Actually, heat treatment done by heating the entire propeller or local heating of the repaired area is a complex, expensive and difficult-to-perform operation. Creation of mobile and practically feasible techniques for improvement of corrosion fatigue resistance of welded joints and weld deposits as a means of omitting local heat treatment or furnace heat treatment is a topical issue in propeller fabrication. Germanischer Lloyd notes that in specific cases the classification society is entitled to approve stress removal rather than tempering procedure provided that the technique is approved by classification society for this particular purpose.

### **3. OBJECTIVE OF WORK**

The intention was to estimate UIT effectiveness, justify and co-ordinate with classification societies (Russian Maritime Register, Germanischer Lloyd, Lloyd's Register of Shipping, Det Norske Veritas) its application on Cu 3 alloy propellers for defect repair by welding (weld deposition) as an alternative to post-weld heat treatment, as well as to develop and introduce the technology.

The work was carried out on the basis of Technical Assignment under the Agreement between NSTC and state enterprise Zvyozdochka, Russia, Severodvinsk.

### **4. DISTINGUISHING FEATURES, NOVELTY AND ADVANTAGES OF UIT**

UIT was developed at NSTC as a process ensuring high quality and reliability of welded structures and constructions. It is used to improve the formation of the weld metal and heat affected zone structure and also to optimize the stressed condition of the welded joint and structure as a whole.

The UIT method is based on conversion of harmonic oscillations of ultrasonic transducer into impact impulses of ultrasonic frequency. Manual or mechanized UIT results in increase of reliability and endurance of metal structures in parallel with drastic reduction of costs for production of high durability structures, including maintenance and repair. The UIT method reduces unfavorable residual tensile stresses, creates beneficial compressive stresses in the weld and at the weld toe region, reduces stress concentrations and improves the corrosion and corrosion fatigue resistance of UIT treated areas.

Currently, NSTC is involved in development of the UIT technique, evaluation of its effectiveness from the technical point of view, and manufacture of the prototype equipment for specific applications.

Thus, NSTC have developed a procedure and in July of 1997 applied UIT for repair of cracked details in the highway bridge over Allatoona Lake, Georgia, USA.

UIT method developed by NSTC is certified by expert and research laboratories of International Institute of Welding of France, Sweden, Norway, Japan, USA and Ukraine.

UIT method allows for:

- increase in fatigue resistance and life of welded joints;
- increase in corrosion fatigue strength;
- reducing a level of residual welding stresses and deformations;
- omitting traditional methods of stabilizing heat treatment;
- achieving high processability of welded joint treatment using mechanical or manual equipment in actual conditions of production, installation, maintenance and repair of various-purpose structures.

## **5. UIT EQUIPMENT**

UIT equipment (Fig. 1) developed and manufactured at NSTC comprises the following components:

- power supply UPS MT-5 APS-2000,
- ultrasonic generator UPS MT-5 UGenerator,
- ultrasonic impact tool.

## **6. MATERIAL**

Bronze Cu 3 has been the most commonly used material for production of propellers in Russia. Under contracts with international companies, Zvyozdochka Yard has been fabricating and delivering propellers made from this bronze. For instance, Zvyozdochka has fabricated and delivered bronze propellers of AZIPOD propulsion unit for cruise liners built in Finland.

Within the framework of this study, a comparison study was made of mechanical and corrosion fatigue characteristics and properties of welded (deposited) joints on special test specimens:

- in the initial condition,
- after heat treatment,
- after ultrasonic impact treatment.

A special programme of comparison tests based on the requirements of the classification societies has been developed for this study.

Plates cast from Cu 3 bronze and manufactured at Baltiysky Zavod, St. Petersburg were used as the base metal. Mechanical properties and chemical composition of the above bronze are presented in Table 1 and Table 2.

**Table 1** Mechanical properties of bronze

Material Grade	Ultimate tensile strength, kg/mm <sup>2</sup>	Yield strength, kg/mm <sup>2</sup>	Elongation, %	Brinell hardness number
BrAl9Fe4Ni4 bronze grade	66,0 – 67,0	29,0	17,0 - 19,0	163

**Table 2** Chemical composition of bronze

Cu	Al	Fe	Ni	Mn	Sn	Pb	P
The rest	9,50	4,12	4,13	0,82	0,011	0,005	0,004

## 7. WELDED JOINT QUALITY ANALYSIS

In compliance with the requirements of classification societies, special butt welded plates (Fig.2) were produced to determine the effect of heat treatment and ultrasonic impact treatment on the mechanical properties and macrostructure of welded joints. The thickness of plates to weld was 40mm, so that after welding it would be possible to mill them down to a thickness of 30mm, refer to Fig. 2.

One plate was a base metal without weld.

Five plates were butt welded:

- one for as-welded joint analysis,
- one for heat treated welded joint analysis,
- three for analysis of welded joint subjected to UIT of each pass.

Each welded plate was cut into two tensile test specimens for strength determination and three macrostructure test specimens (see Fig. 2).

Plates were welded by the TIG process using alternate welding current. BrAlFeNiMn 8,5-4-5-1,5 bronze was used as a filler material. Chemical composition of filler rods is presented in Table 3.

**Table 3** Chemical composition of filler material

Cu	Al	Fe	Ni	Mn	B	V
The rest	8,2-9,0	3,7-4,3	4,7-5,3	1,0-1,8	0,005-0,01	0,005-0,01

**Welding operation** was performed by certified welders of Zvyozdochka Yard in compliance with welding data sheet issued by Chief Welder Department.

Welding conditions:

- preliminary misalignment of plates to be welded for welding deformation compensation,
- degreasing groove faces prior to welding,
- heating the butt joint up to temperature of 50±5 degrees C prior to welding,
- filler rod 4mm in diameter,

- welding current 300 – 320amp,
- argon flow: 12 – 15 liter/min,
- every consequent bead was deposited after thorough wire brushing of the previous bead,
- every consequent bead was deposited after cooling of the previous bead down to a temperature 150<sup>0</sup>C max,
- weld root was removed with abrasive tools and welded.

Each weld pass of three joints was subjected to ultrasonic impact treatment (Fig. 3).

**Ultrasonic impact treatment** was performed in compliance with «Recommendations on ultrasonic impact treatment of welded joints» developed at NSTC with the following conditions:

Manual UIT tool was fixed at right angles to the surface to be treated and pressed against it with an axial force of 20-40N (2-4kg). This force, as a rule, is created by the weight of the tool itself.

UIT was performed through headway and shuttle movement of the tool over the weld surface and along the weld toe and inter-bead toes until uniformly treated surface, corresponding to reference specimens, was formed.

#### **UIT parameters:**

- frequency of the ultrasonic generator 27kHz,
- current of polarization 10 – 14amp,
- oscillation amplitude of the output end of the waveguide 25 - 40 microns is automatically controlled by setting the output power in the range of 600 - 1200W,
- diameter of impact pins (indenter) 3mm, 3-4 pins in a row,
- average travel speed 0,3 - 1,5 m/min.

Visual and X-ray examination was used to inspect welded joints. No unacceptable defects were detected.

One welded joint (plate No. 2/4) was stress relieved by heat treatment in accordance with conditions specified by Det Norske Veritas.

Zvyozdochka Yard produced a heat treatment data sheet. Heat treatment conditions:

- |                       |   |
|-----------------------|---|
| - heating speed       | - not more than 80 <sup>0</sup> C an hour   |
| - heating temperature | - 675 <sup>0</sup> C,   |
| - soak time           | - 30 min.,  |
| - cooling speed       | - in furnace not more than 50 <sup>0</sup> C an hour down to 200 <sup>0</sup> C, then in air. |

Dye penetrant inspection was performed after milling of the specimen down to the thickness of 30mm. Defects like cavities, pores, cracks were not detected.

The results of the mechanical tests are presented in Table 4. All the specimens failed in the base metal outside the weld zone (Fig. 4) and the properties satisfied DNV and Germanischer Lloyd requirements.

**Table 4** Mechanical test results

Specimen type	Ultimate tensile strength, MPa	
	Value	Average value
Base metal	579, 589	584
As welded joint	598, 598	598
Heat treated welded joint	629, 579	604
UIT treated welded joint	578, 589, 579, 569, 540, 579	572

The macrostructure was studied for the presence of defects. In compliance with Det Norske Veritas and Germanischer Lloyd, pores more than 3mm in size and cracks are not acceptable. The present welds were free of any pores, cracks and discontinuities (Fig. 5).

Based on the results of works performed and analysis of weld quality, it can be concluded that welding followed by ultrasonic impact treatment ensures good weld quality with mechanical properties not inferior to those of as-welded joints and welded joints subjected to stress-relieving heat treatment.

## 8. SPECIMENS FOR CORROSION FATIGUE STUDIES

In order to determine the effect of ultrasonic impact treatment and heat treatment on the corrosion fatigue properties of the base material and weld deposit areas of bronze propellers, special full-scale specimens were made for corrosion fatigue tests (Fig. 6).

The thickness of specimens prior to weld deposition was 22mm so that after depositing a zone of 60x100mm (Fig. 6) it would be possible to mill them down to a thickness of 20mm, as shown in Fig. 2.

Specimens of one series were the base metal without weld deposit.

Specimens of three series incorporated a weld deposit:

- one for testing specimens in the as-deposited condition,
- one for testing heat treated specimens containing weld deposit,
- one for testing UIT treated specimens containing weld deposit. Ultrasonic impact treatment was applied after deposition of each bead. In addition, UIT of the entire surface of the specimen was performed after removal of the excess metal (by grinding). In so doing, both base and deposited metal were treated by UIT.

Each series consisted of 10 specimens.

Specimens were weld deposited by the AC TIG process. BrAlFeNiMn 8,5-4-5-1,5 bronze was used as a filler rod (Fig. 7.).

Deposition operation was performed by certified welders of Zvyozdochka in accordance with a data sheet for deposition.



Weld deposition conditions:

- prior to welding groove faces were degreased,
- prior to welding specimens were heated up to  $50 \pm 5$  degrees C,
- filler rod 4 mm in diameter,
- welding current: 300 – 320amp,
- argon flow: 12 – 15 liter/min,
- every consequent bead was deposited after thorough brushing of the previous bead,
- every consequent bead was deposited after cooling of the previous bead down to a temperature  $150^{\circ}\text{C}$  max,
- weld metal was alternately deposited on each side of the specimen to avoid distortion.

One series of welded specimens was subjected to UIT of each weld pass. UIT conditions were in compliance with those specified in Section 7.

The appearance of an as-welded specimen is shown in Fig. 8. Deposited metal on one specimen underwent ultrasonic impact treatment.

Weld deposition, both before and after machining, was inspected by visual (dye penetrant) and X-ray examination. No unacceptable defects were detected.

One series of 10 specimens (No. 2/1 - 2/10) was subjected to stress relief heat treatment to conditions specified by Det Norske Veritas.

After final fabrication, all surfaces of specimens of series 3 were treated by mechanized UIT, including both deposited weld area and base metal to relieve residual welding stresses and harden the surface layer of the base metal and deposit (Fig. 9). This UIT technique would be intended to increase the corrosion fatigue strength of the entire propeller blade.

#### **UIT parameters:**

- frequency of the ultrasonic generator	27kHz,
- polarization current	10amp,
- oscillation amplitude of output end of the waveguide	20 – 25 microns,
- output power	600 - 800W,
- pin	one 5mm in diameter,
- longitudinal feed of the machine-tool	400mm/min,
- transverse feed	0,5mm/pass

## **9. HARDNESS TESTS**

To check the effect of UIT on the surfaces of the weld and base metal, Brinell hardness tests were conducted.

A 10mm diameter ball with 1000kgf force was used. The results, which refer to the measurement locations shown in Fig. 10, are presented in Table 5.

It will be noted that the hardness of specimens subjected to additional treatments has increased significantly. The hardness of the deposited metal in the heat treated specimens is somewhat higher than that after UIT treatment. However, UIT produced the highest hardness in the base metal.

**Table 5** Bronze specimen Brinell hardness test results

Specimen No.	Hardness in deposition area			Hardness of UIT treated base metal			Hardness of base metal		
	Measuring point	HB	Average HB	Measuring point	HB	Average HB	Measuring point	HB	Average HB
2/1 (HT)	1	209	213	---	---	---	6	148	150
	2	218					7	148	
	3	209					8	153	
	4	218					9	148	
	5	209					10	153	
3/1 (UIT)	1	200	200	6	193	190	11	148	145
	2	200					7	185	
	3	200					8	193	
	4	200					9	185	
	5	200					10	193	
4/1	1	159	159	---	---	---	6	129	133
	2	159					7	134	
	3	159					8	134	
	4	159					9	134	
	5	159					10	134	

## 10. RESIDUAL STRESS MEASUREMENTS

Residual stresses in the surface layers of the base and deposited weld metal were determined for one specimen from each series by X-ray diffraction analysis.

Residual stresses were determined in the areas indicated in Fig. 11 in four specimens:

- No. 1/1 – base metal
- No. 2/1 – heat treated specimen containing deposit
- No. 3/1 – UIT treated specimen containing deposit
- No. 4/1 – base metal containing deposit

At each point, residual stresses were measured in two directions, longitudinal and transverse (Fig. 12-15).

The tests were conducted after preliminary electropolishing of the test area to a depth of 0,1mm. Electropolishing conditions: electrolyte «A», current - 10A, cathode – stainless steel, time -50 min.

Average values of the residual stresses measured are given in Table 6.

**Table 6** Average residual stresses

Specimen No.	Average residual stress, MPa			
	Along the X axis		Along the Y axis	
	In longitudinal direction	In transverse direction	In longitudinal direction	In transverse direction
1/1	-250,84	-182,52	-196,17	-195,62
2/1	-43,16	-57,98	-38,62	-54,25
3/1	-432,64	-380,33	-384,99	-399,58
4/1	-14,42	4,08	-24,13	-6,18

It is clear that the highest level of compressive stress in the surface layer was obtained from the specimen No. 3/1, i.e. after deposition and ultrasonic impact treatment.

## 11. CORROSION FATIGUE TESTING

Corrosion fatigue tests were performed in simulated sea-water.

The intention was to assess the improvement in corrosion fatigue strength of bronze propellers achieved by heat treatment or ultrasonic impact treatment, on the basis of fatigue test results obtained from flat specimens.

3% sodium chloride distilled water was used as the corrosive environment. The reason is that salt content in different seas ranges from 8 to 42% while the minimum conventional endurance limit of many materials is found in 3% ....3,5% brine.

Fatigue tests on specimens should be carried out under the most adverse cycle forms of corrosive environments, i.e. harmonic and triangular. Axial harmonic tension were realized at a stress ratio  $R = + 0,5$  which is close to propeller main load variation mode in service.

Specimens were fatigue tested under soft load conditions in the high-cycle regime at a frequency of 4-5Hz. Specimens of each series were tested using 9 stress range levels with stress levels chosen to give lives in the range  $N 10^5$  to  $2 \times 10^6$  cycles. Specimens were tested to complete failure. The moment of formation of the surface fatigue crack 4-5mm long was recorded.

The tests were performed using specially designed and fabricated equipment: a chamber and devices for forced circulation of corrosive medium, electron-optical system for measuring fatigue crack size during testing large-scale specimens.

The benefit of the post-weld treatment was determined through comparison of the corrosion fatigue curves from three series of specimens:

- 1) base metal;
- 2) heat treated specimen with weld deposit;
- 3) UIT treated specimen with weld deposit.

All fatigue curves are shown in Fig. 16 with the same scale for ease of comparison, while Fig. 17 shows a comparison of the fatigue strengths obtained at various endurance.

Based on a comparison of fatigue test results, the corrosion fatigue resistance of UIT treated bronze specimens containing weld deposits is about 86% of the corrosion fatigue resistance of the base-metal specimens in the low-cycle regime, and about 94% in the high-cycle regime. By comparison, the corrosion fatigue resistance of heat treated specimens in the same regimes is respectively 93% and 90% of the base metal. This suggests that in synthetic salt water the benefit of UIT of deposited welds increases with reduction in variable amplitude loading level, and conversely in the case of heat treatment. This is due to non-parallelism of fatigue curves for the base metal and improved specimens with deposits. The fatigue curve slope for UIT treated specimens is lower than that for the base metal. In contrast, the fatigue curve slope for heat treated specimens is higher than that for the base metal.

### 11.1. Conclusions

- The fatigue strength at  $2 \times 10^6$  cycles obtained from UIT treated bronze specimens containing weld deposit is 140MPa, 93% of the value obtained from the base metal bronze specimens. This value is slightly higher than that obtained from the heat treated specimens with weld deposit.
- All the UIT treated specimens fatigue cracked in the base metal as against the heat treated specimens, which also failed at deposited metal or at deposit-base metal toes. Test results obtained from UIT treated specimens were less scattered as compared with those obtained from the base metal and heat treated specimens.
- The slope of fatigue S-N curve for UIT treated specimens is lower than that for the base metal and heat treated specimens. Hence, in the low-cycle regime the fatigue strength of UIT treated specimens is somewhat lower than that obtained from the base metal and heat treated specimens. However, for lives above 1 million cycles the lower fatigue curve slope for UIT treated specimens brings it closer to the fatigue curve for the base-metal specimens in Cu 3 bronze.

## 12. ANALYSIS OF UIT EFFECT ON ETCHING

During residual stress analysis in the surface layers of bronze specimens UIT was found to have the beneficial effect in terms of etching action.

The base and deposited metals both in the untreated and UIT treated conditions were subject to electropolish etching to the depth 0,1mm. Electropolishing conditions were:

- electrolyte “A”;
- current 10A;
- cathode – stainless steel;
- etching time - 50 minutes
- temperature 60<sup>0</sup>C.

Electrolyte “A” is orthophosphoric acid (H<sub>3</sub>PO<sub>4</sub>)-base electrolyte with addition of sulfuric acid (H<sub>2</sub>SO<sub>4</sub>) and chromium anhydride (Cr<sub>2</sub>O<sub>3</sub>).

Two specimens No. 3/1 and 4/1 were studied. Specimen No. 3/1 were treated by ultrasonic impact treatment, specimen No. 4/1 is in the as-deposited condition (untreated), see Fig. 18.

Specimen material is bronze grade Cu3, weld deposit material is bronze Br AlFeNiMn 8,5-4-5-1,5.

The etched areas on the base and deposited metal were photographed with magnification.

### 12.1 Comparative description

The etched surfaces were visually inspected using no magnifying devices and with the aid of binocular microscope MBS-9 of LOMO and metallurgical microscope MeF-4 of Reichert Jung.

The areas of the base and deposited metal were defined as a result of the etching process (Fig. 19 and 20). By visual inspection it was found that, after etching, the base metal differs from the deposited metal by higher surface roughness. Weld deposition was performed by TIG process using an argon shielding gas and filler rods. The weld deposits have more pure chemical composition, less segregation inclusions and more solid structure as compared to the as-cast metal. This is supported by the etch pattern on the surface, see Fig. 19 and 20 where the base metal is seen to be corroded to a greater extent than the deposited metal.

On etching, the base metal areas not treated by UIT were found to differ significantly from the UIT treated base metal (Fig. 19 and 20).

By visual inspection it was found that the untreated metal (Fig. 20), after etching, has higher roughness than UIT treated metal (Fig. 19). In addition, the metal not treated by UIT has deep pitting randomly arranged on the etched surface.

Thus, the untreated base metal suffers higher corrosion damage as compared to the UIT treated base metal.

At the magnification (X20, 40, 50-1000), it is seen that:

- UIT treated base metal is covered with pitting 10-15 microns in depth and separate spot pits with depth of not more than 30 microns (Fig. 21).

- Untreated base metal has the surface roughness governed by uneven etching of separate constituents. The level difference between the constituents is about 10 microns. Considerable amount of spot pits is up to 80 microns in depth (Fig. 22).

After comparative analysis of specimens No. 3/1 and 4/1, the following was observed.

The etched surface of the untreated base metal differs from the etched base metal subjected to UIT by the presence of a great number of large pits visible with the naked eye.

In addition, the surface of the UIT treated material, after etching, remains smooth and not damaged by corrosion.

The corrosion resistance in the surface layer of the cast bronze increases when UIT treatment is applied.

### 13. ANALYSIS OF UIT TREATED MATERIAL IN DEPTH

UIT hardens the surface layers of the metal.

This study is intended to determine a depth of hardened layer on a bronze specimen. Plate material is bronze of grade Cu 3, and weld deposit material is bronze of Br.AlFeNiMn 8,5-4-5-1,5 grade. Manual UIT treatment was applied both to the base and deposited metal.

The effect of the surface finish by soft Durex disk (flexible abrasive disk) to the depth of remained hardened layer was also studied. For this purpose, the portion of the UIT treated plate was worked with Durex disks.

The depth of the hardened layer was determined by defining actual values and the mechanism of microhardness distribution obtained in the metal to a depth of up to 1.5mm.

The microhardness was measured using PMT-3 device under loading 0.490N (50 g-force) by indentation of tetrahedral diamond pyramid (HV 0,05).

Microhardness was obtained in five points indicated in Fig. 23.

- zone No. 1 – the surface treated by manual UIT. Surface roughness in  $R_z = 29,1-52,9$  microns, and in  $R_a = 5,1-12,5$  microns:
  - point 1 – base metal,
  - point 2 – deposited metal;
- zone No. 2 – the surface treated by manual UIT followed by the surface finish with the manual abrasive tool (soft Durex disk). Surface roughness in  $R_z = 9,08-10,47$  microns, and in  $R_a = 2,154-2,235$  microns:
  - point 3 – deposited metal;
  - point 4 – base metal,
  - point 5 – base metal. The surface was treated by the manual abrasive tool (soft Durex disk) followed by manual polishing. Surface roughness in  $R_z = 1,36-4,50$  microns, and in  $R_a = 0,55-1,08$  microns.

The microsections were then made through the above points to measure the microhardness at 15 levels from the surface. First measurement point located at the minimal-allowable distance from the surface equal to 0.04mm. The rest measurement points were spaced at 0.1mm intervals.

### 13.1 Microhardness measurement results

Microhardness measurement results are presented in Figs. 24-30.

UIT produced a hardened layer to a depth more than 1,5mm. Subsequent surface finish by soft Durex disk reduces the depth of a hardened layer by 0,3-0,5mm, resulting in a hardened layer of a depth not less than 1mm.

UIT produces quite new surface layer in propellers in bronze Cu 3.

## 14. CONCLUSIONS

- A method has been developed for repairing casting defects with application of welding and concurrent layer ultrasonic impact treatment during manufacture of propellers from bronze Cu3, allowing heat treatment to be omitted. Layer (during welding) and final ultrasonic impact treatment produces high-quality welded joint that are not inferior to that subjected to heat treatment.

A method is based on the use of multifrequency UIT with carrier frequency of 27kHz. The power and repetition rate of ultrasonic impacts are determined by the treatment procedure.

- Analyses of corrosion fatigue characteristics of large-scale base-metal specimens, heat treated specimens with weld deposit and UIT treated specimens with deposit showed that in the region of actual loads of marine propellers UIT gives much higher corrosion fatigue life for bronze blades with weld deposits compared to heat treatment.
- UIT increases the corrosion resistance of the as-cast bronze propeller surface in aggressive environment.
- The surface treated by mechanized UIT is given a roughness  $R_a = 0,07 - 0,65$  microns, that is not lower than class 7. This is higher than the corresponding requirements to the quality of the propeller surface.
- UIT produces the hardened layer on the surface to a depth not less than 1,5mm. Surface finish, after manual UIT, using soft Durex disk reduces this layer only by 0,3-0,5mm. Thus, the depth of the UIT hardened layer after surface finishing with Durex disk is not less than 1mm.
- Manual multifrequency UIT with carrier frequency of 27kHz increases the quality, endurance and reliability of propellers in bronze Cu 3 as compared to heat treatment. Manual UIT treatment fits well with the actual propeller manufacturing conditions and being highly effective and inexpensive method.
- Manual multifrequency UIT with carrier frequency of 27kHz treatment does not eliminate the possible application of conventional process steps for finishing a propeller surface (Durex disks). These steps can be added to the manufacturing process after UIT application.

- Mechanized multifrequency UIT with carrier frequency of 27kHz allows the development of the propeller technology, giving propellers new high service performance and characteristics in terms of customer demands.

## 15. REFERENCES

1. E.S. Statnikov. 'Application of Operational Ultrasonic Impact Treatment (UIT) Technologies in Production of Welded Joints'. IIW Doc. XIII-1667-97.
2. E.S. Statnikov, V.I. Trufyakov, P.P. Mikheev and Yu.F. Kudryavtsev. 'Specification for Weld Toe Improvement by Ultrasonic Impact Treatment'. IIW Doc. XIII-1617-96.
3. E.S. Statnikov. 'Comparison of post-weld deformation methods for increase in fatigue strength of welded joints'. IIW Doc. XIII-1668-97.
4. P.J. Haagensen. 'IIW Collaborative Test Program on Improvement Methods'. IIW Doc. XIII-WG2-30-94.
5. P.J. Haagensen , P. d'Erasmus and B. Pettersen. 'Fatigue performance in air and sea water and fracture toughness of TIG-dressed steel weldments'. Proceedings European Offshore Steel Research Seminar, The Welding Institute, Cambridge, UK, 1992. Paper 8.
6. V.T. Troshenko, L.A. Sosnovski. 'Fatigue Resistance of Metals and Alloys'. Reference book. Part 1 Kiev, "Naukova Dumka" 1987.





Fig. 1 UIT equipment

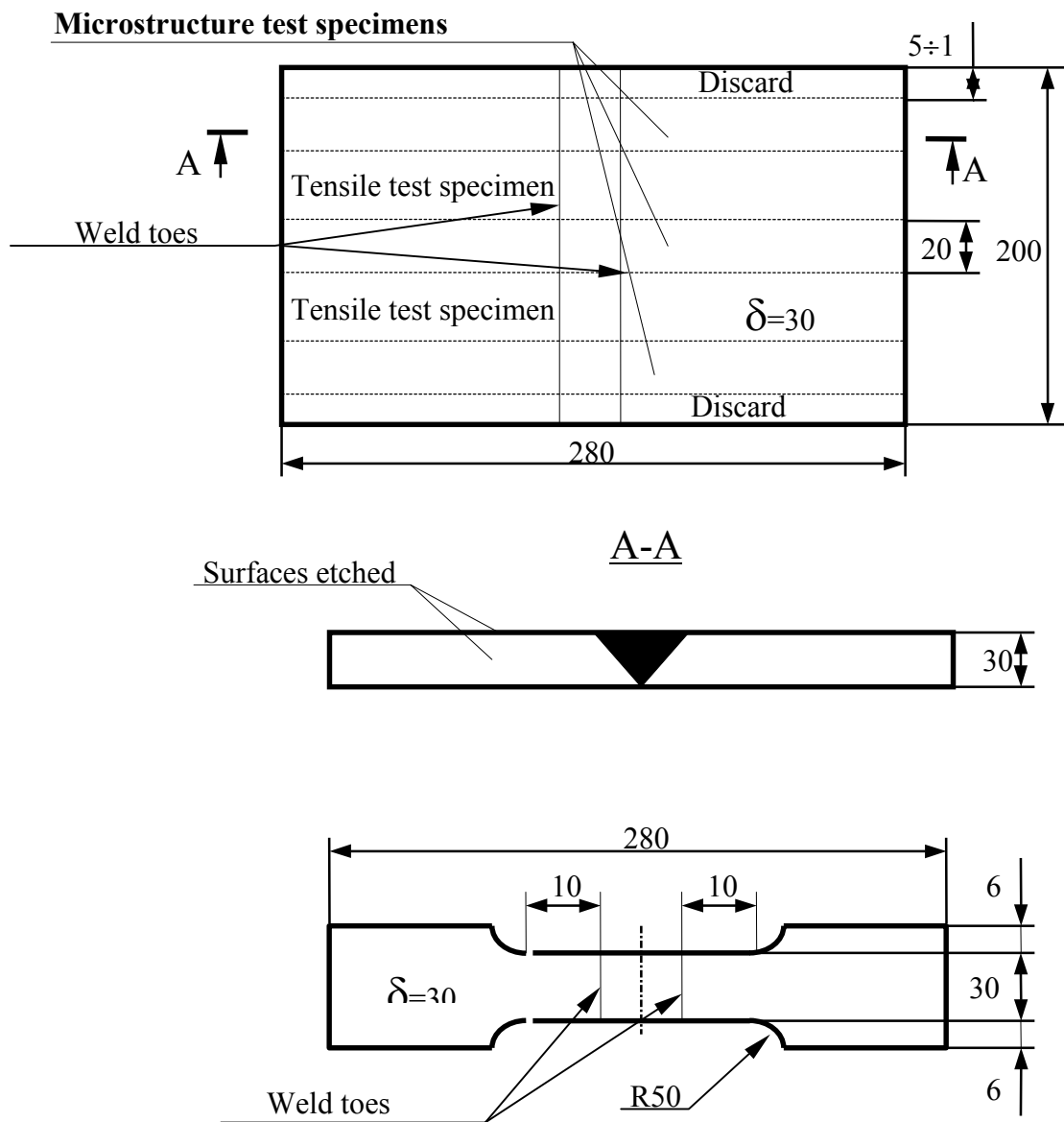

Fig. 2 Butt welded plate and tensile test specimen

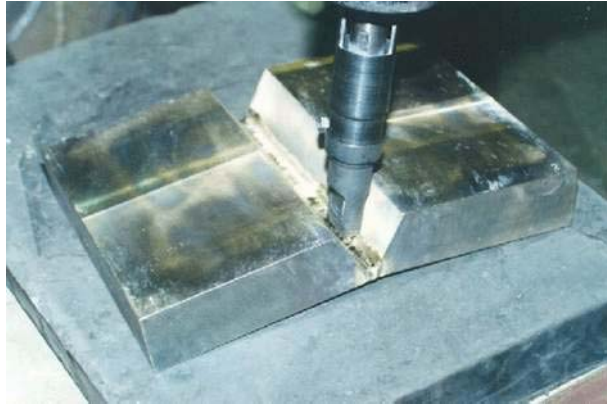

Fig. 3 UIT of each pass

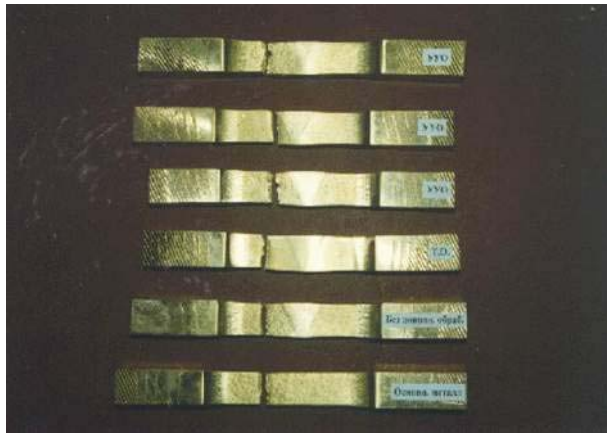

Fig. 4 Failure mode of welded specimens

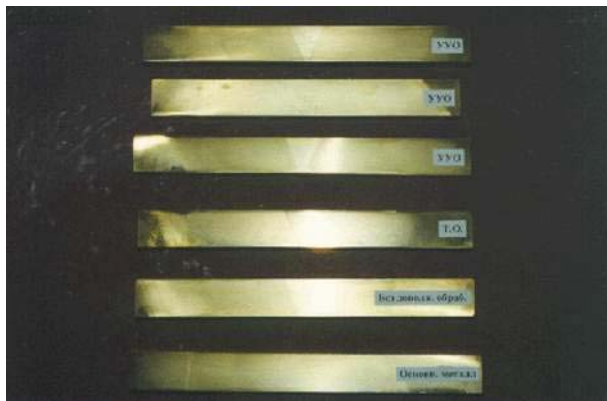

Fig. 5 Welded joints having no defects

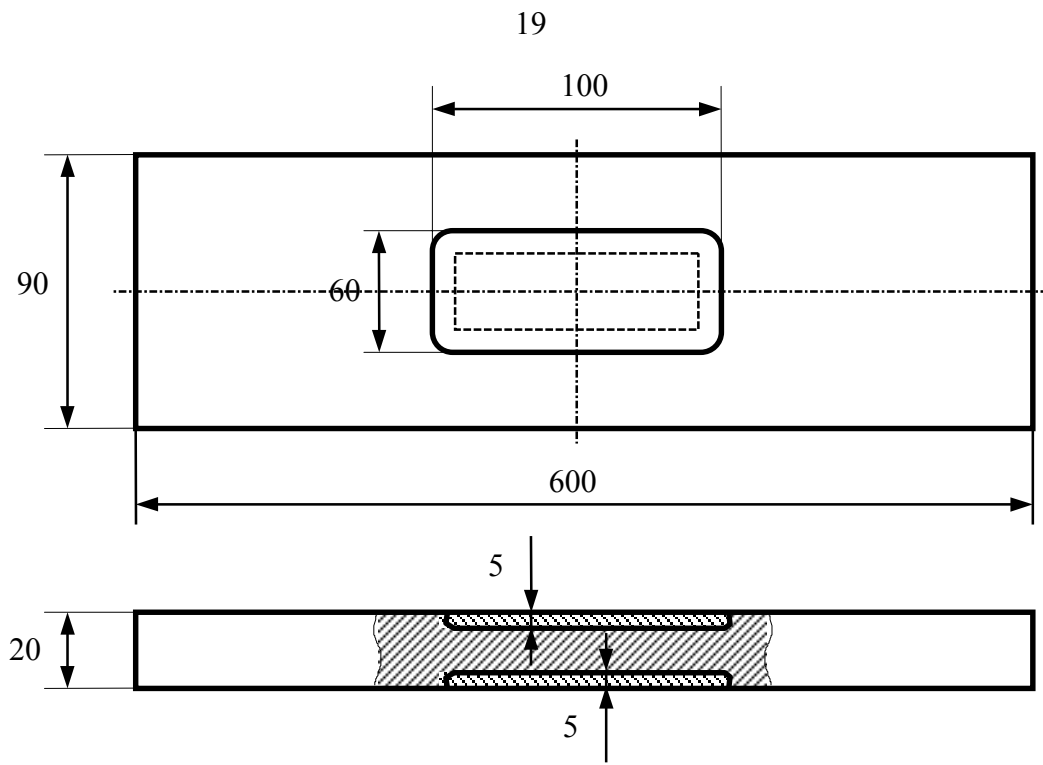

Fig. 6 Corrosion fatigue test specimens



Fig. 7 Weld deposition process



Fig. 8 As-deposited specimens



Fig. 9 Mechanized UIT

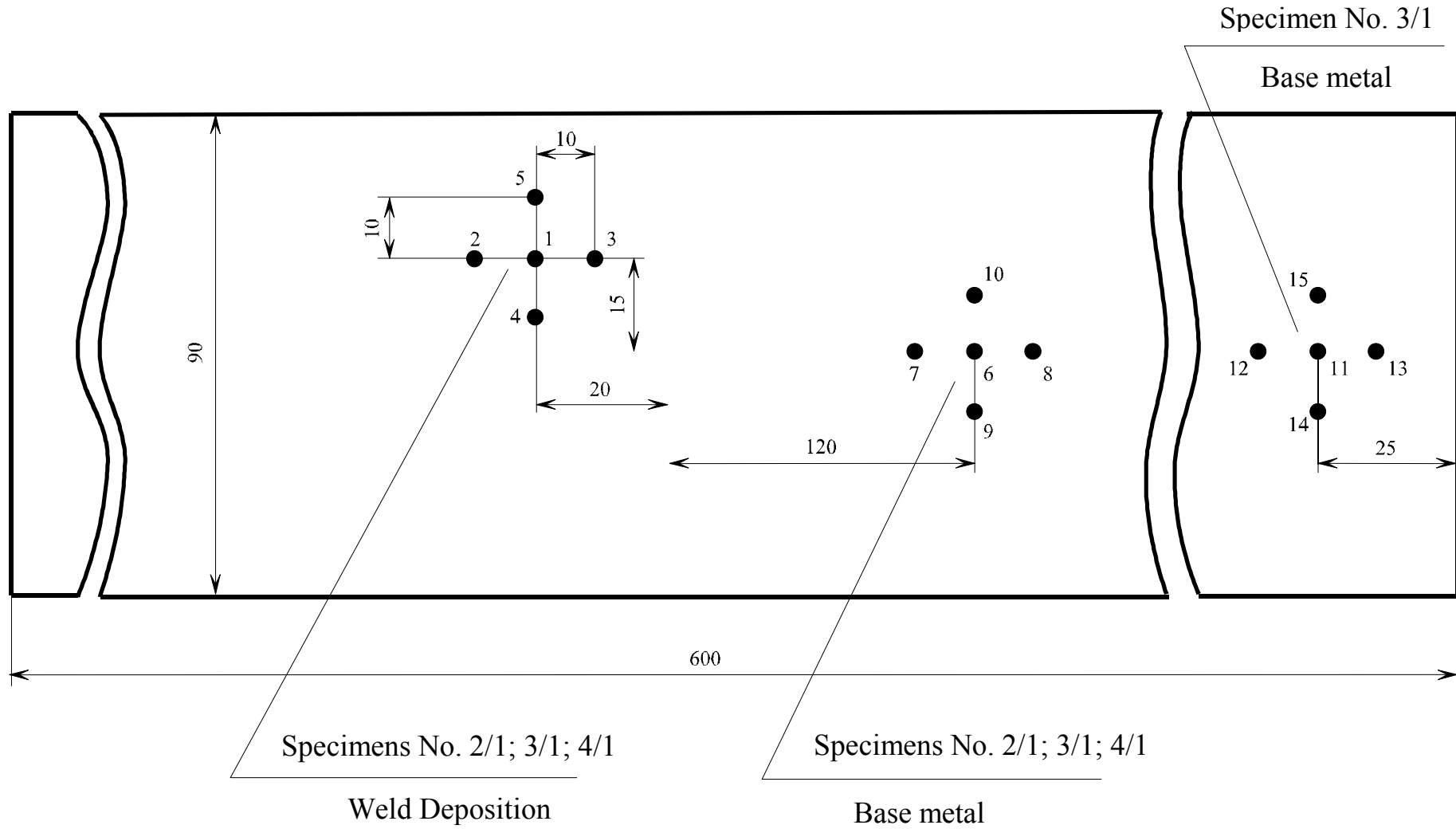

Fig. 10 Diagram of hardness measurement on bronze specimens

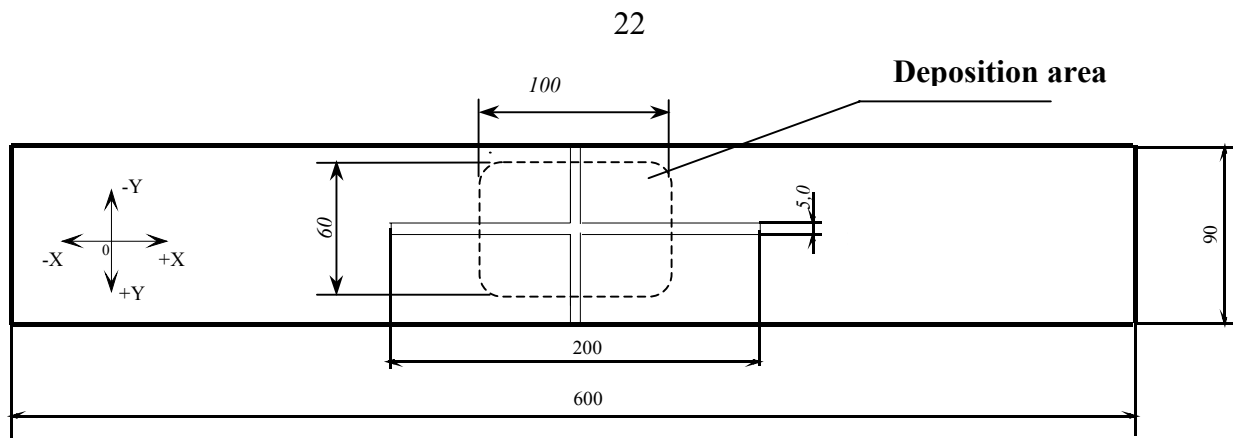

Fig. 11 Layout of areas for measurement of specimen surface residual stresses

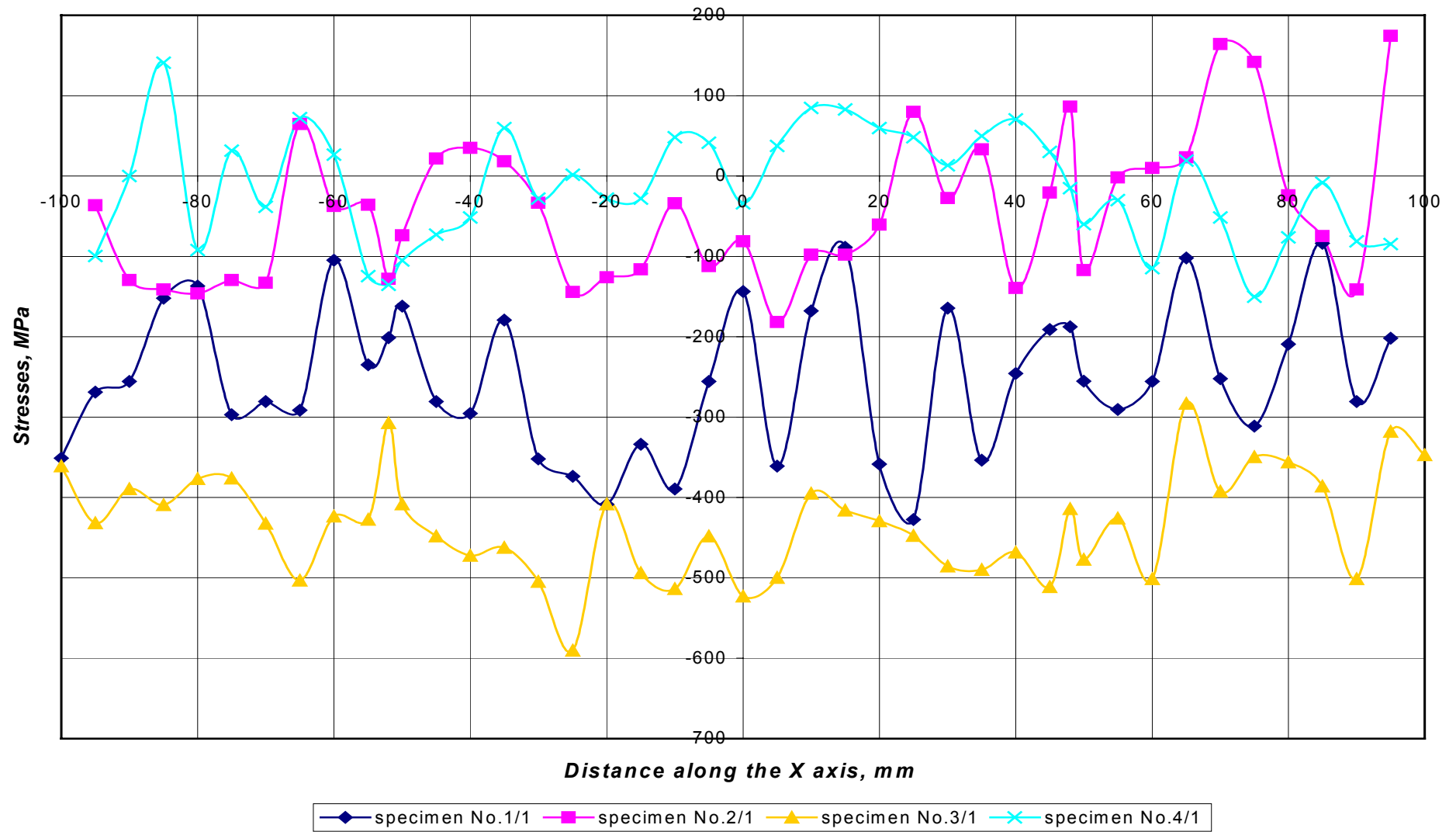

Fig. 12 Diagram of residual stress distribution along the X axis in longitudinal direction

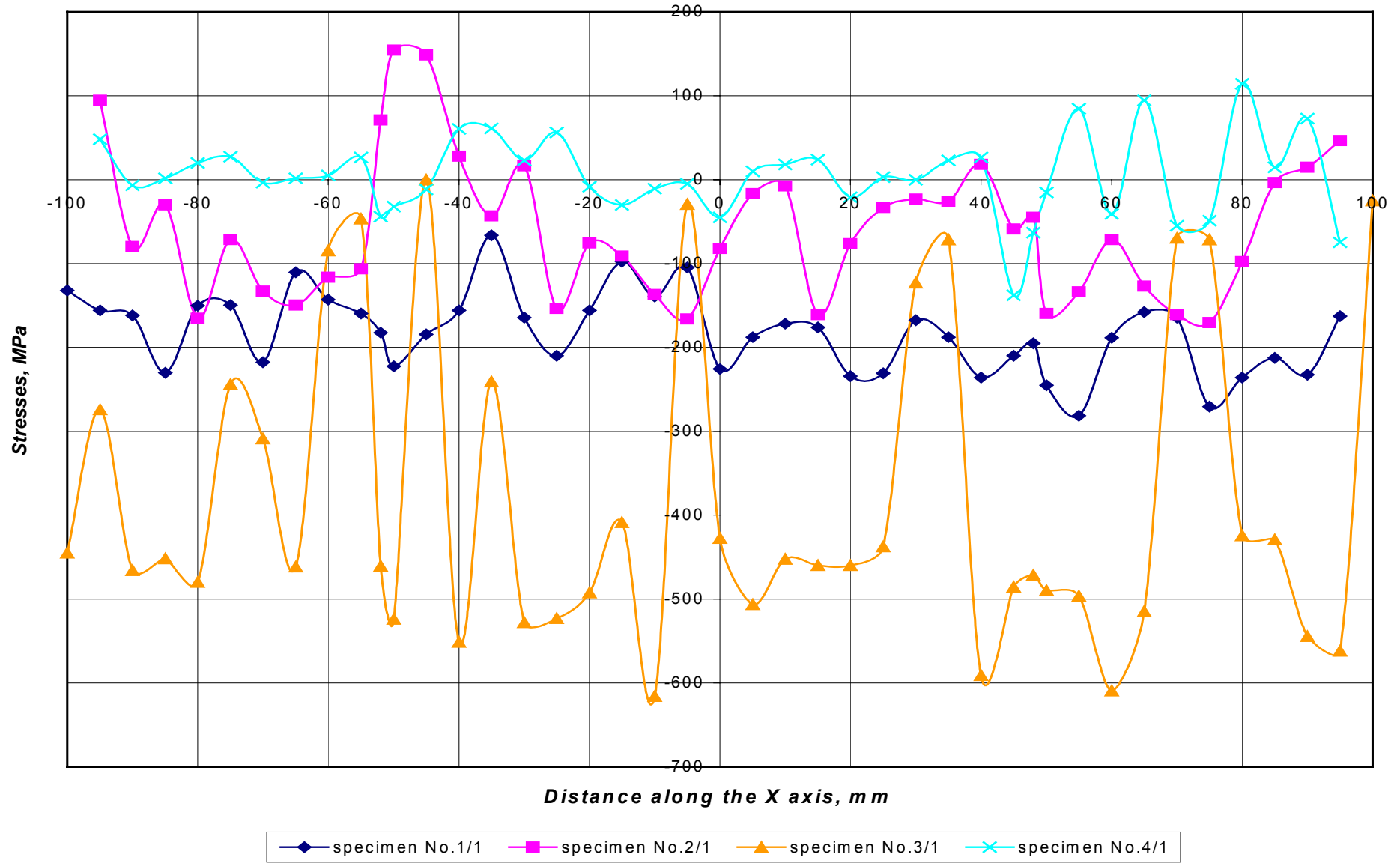

Fig. 13 Diagram of residual stress distribution along the X axis in transverse direction



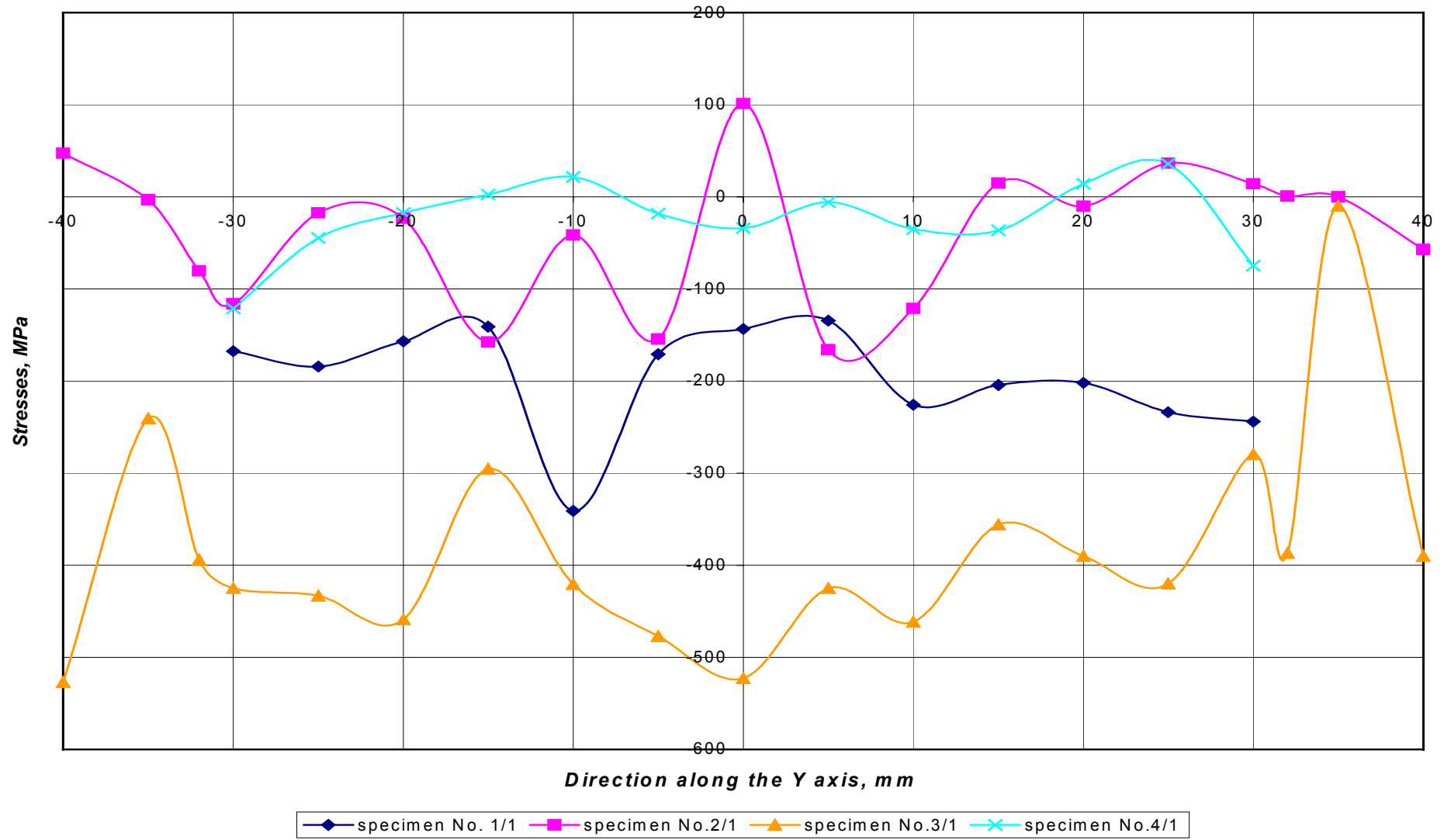

Fig. 14 Diagram of residual stress distribution along the Y axis in longitudinal direction

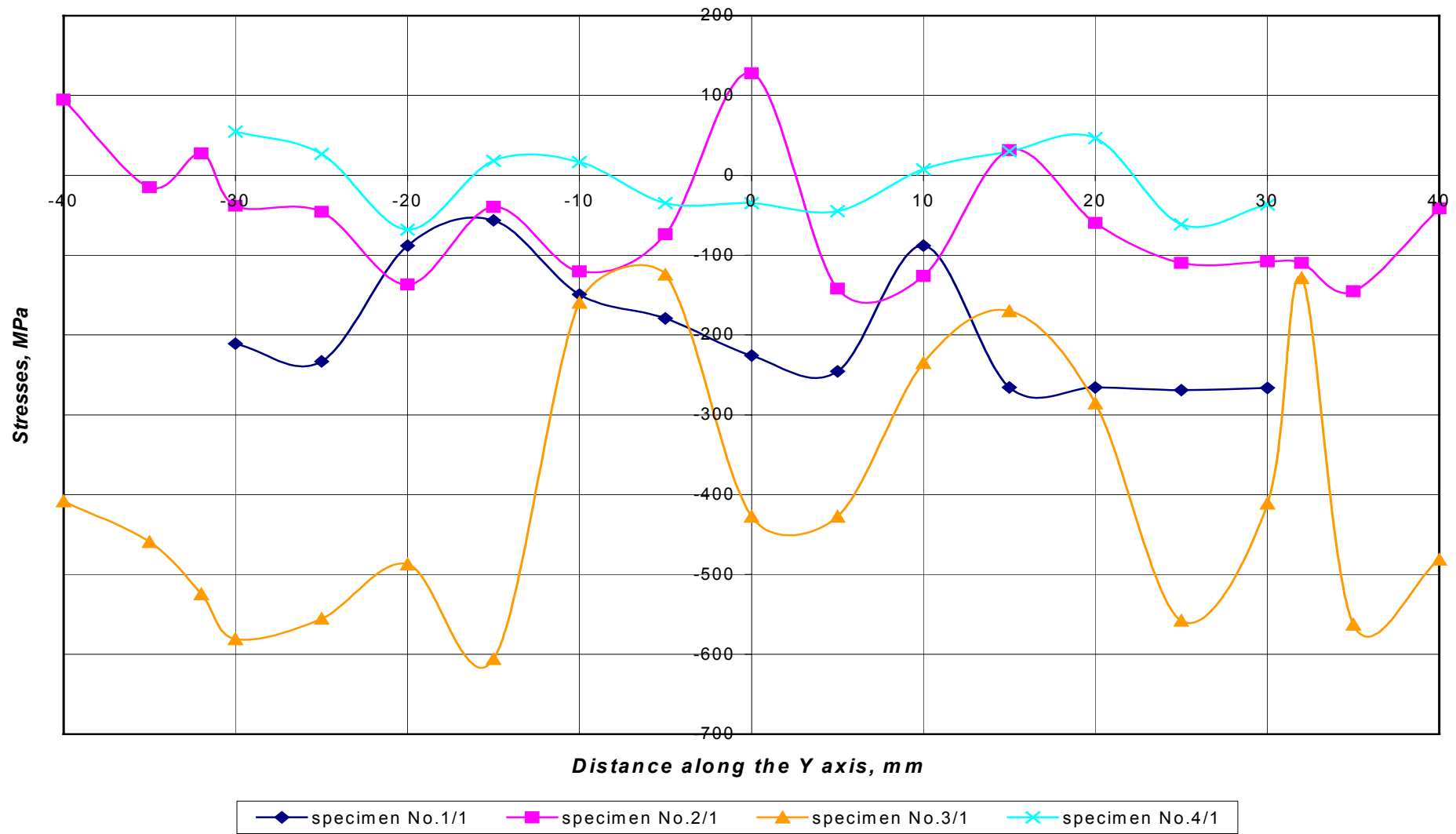

Fig. 15 Diagram of residual stress distribution along the Y axis in transverse direction

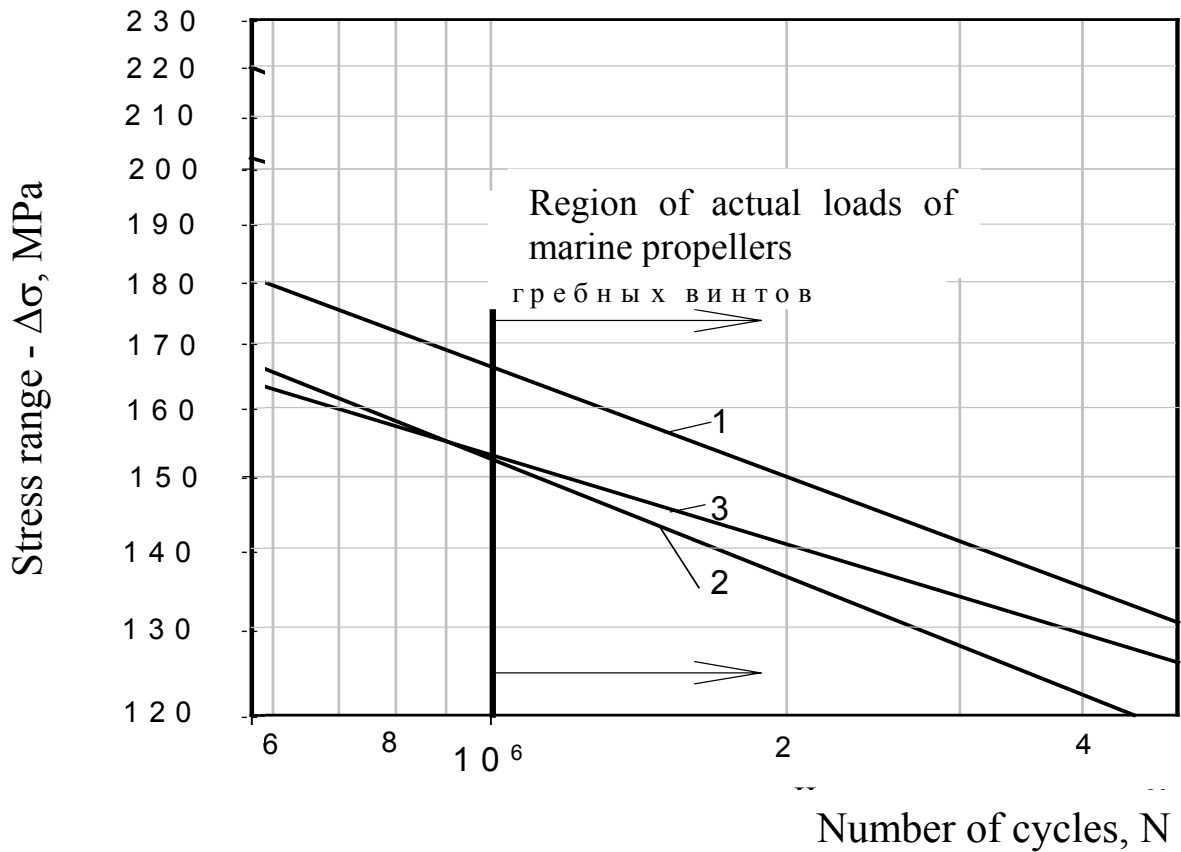
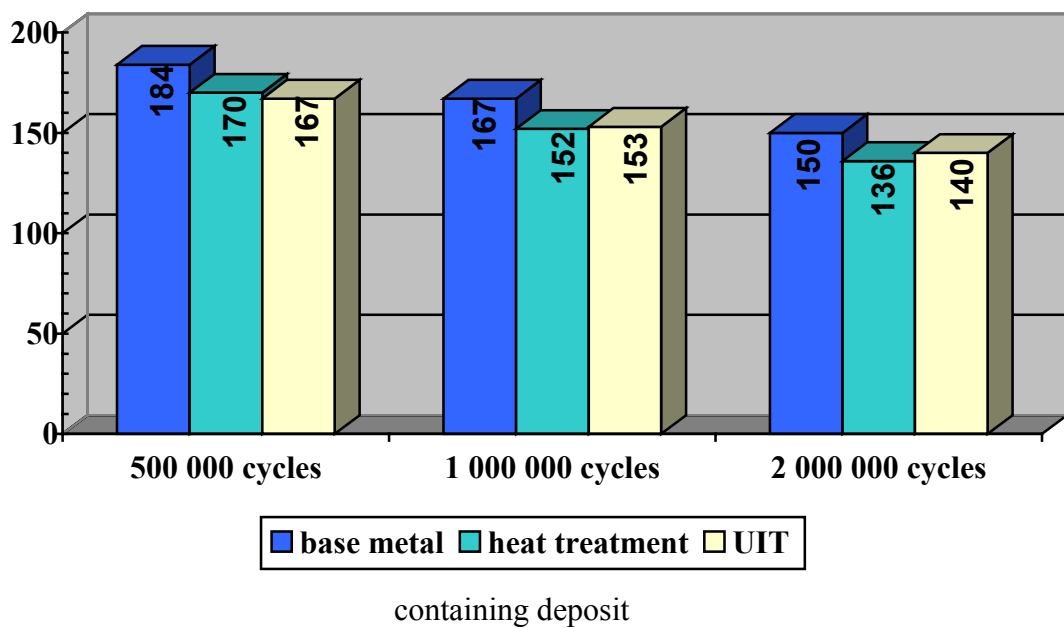

Fig. 16 Fatigue curves for bronze specimens (axial loading  $r = 0,5$ ) in synthetic salt water: 1 – base metal; 2 – deposition plus heat treatment; 3 – deposition plus UIT

Fig. 17 Effect of heat treatment and UIT on corrosion cyclic life of plate in bronze BrA9Zn4N4



containing deposit

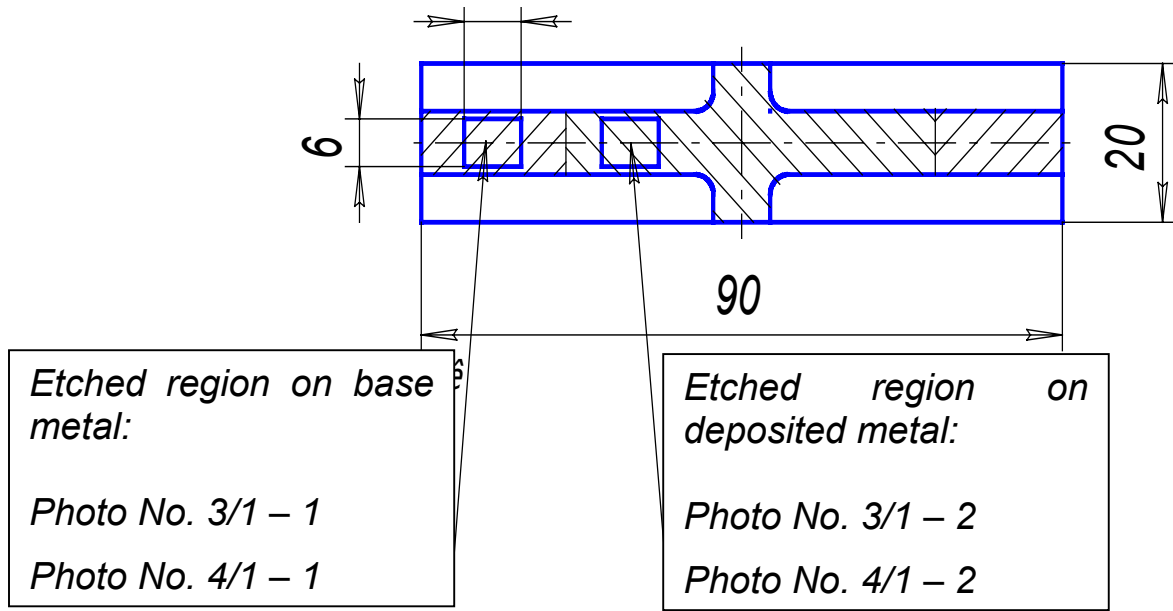
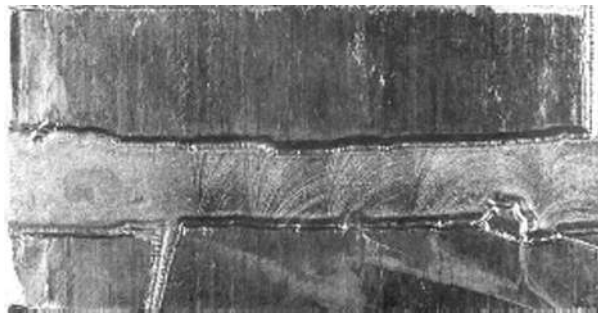
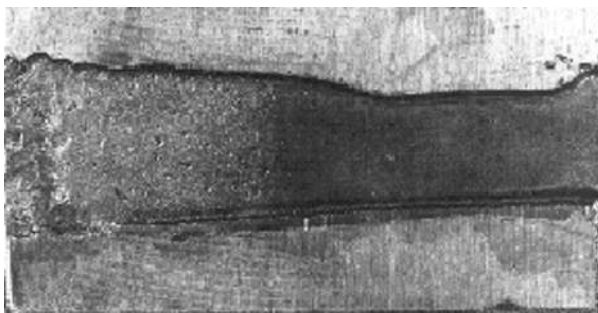

Fig. 18 Specimens No. 3/1 and 4/1



x ~ 2,5

Fig. 19 UIT treated base metal after etching



x ~ 2,5

Fig. 20 Base metal after etching not treated by UIT

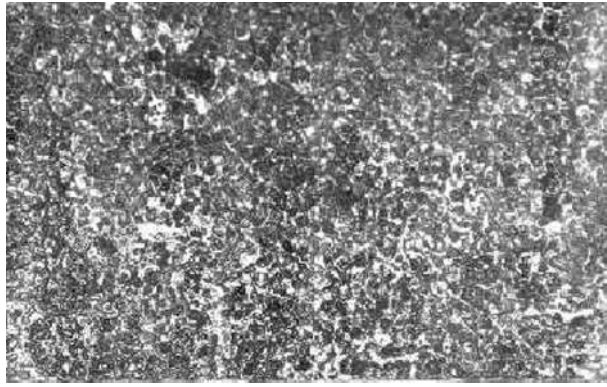

x 50

Fig. 21 UIT treated base metal after etching

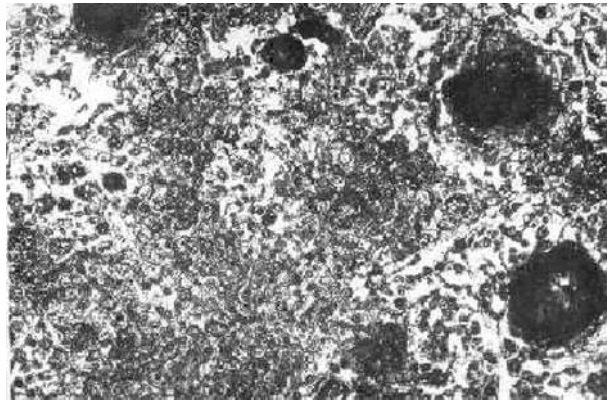

x 50

Fig. 22 Base metal after etching not treated by UIT

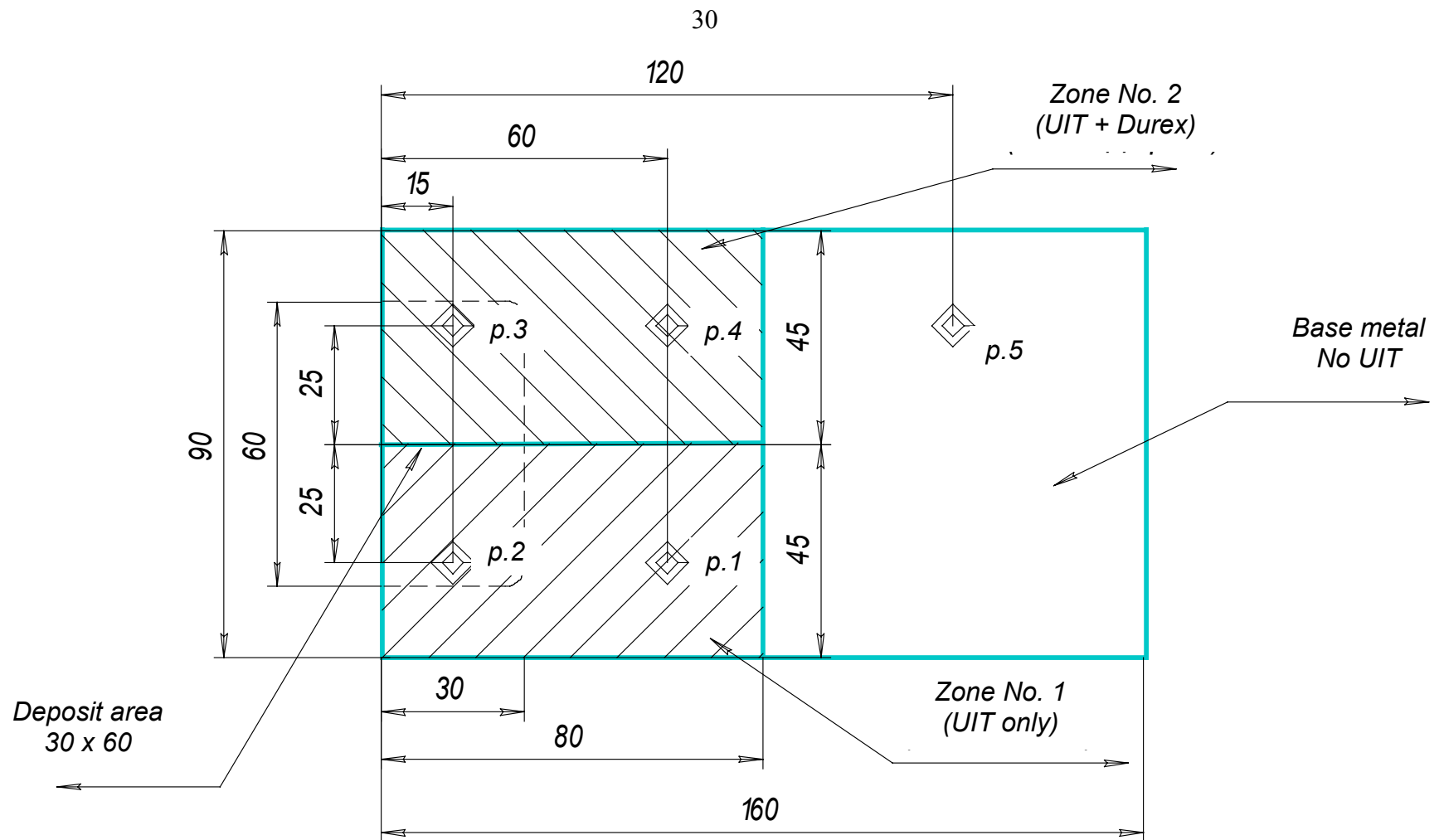

1.	<i>p.1 – p.5 – measuring points</i>
2.	<i>UIT – ultrasonic impact treatment</i>

Fig. 23 Microhardness measurement

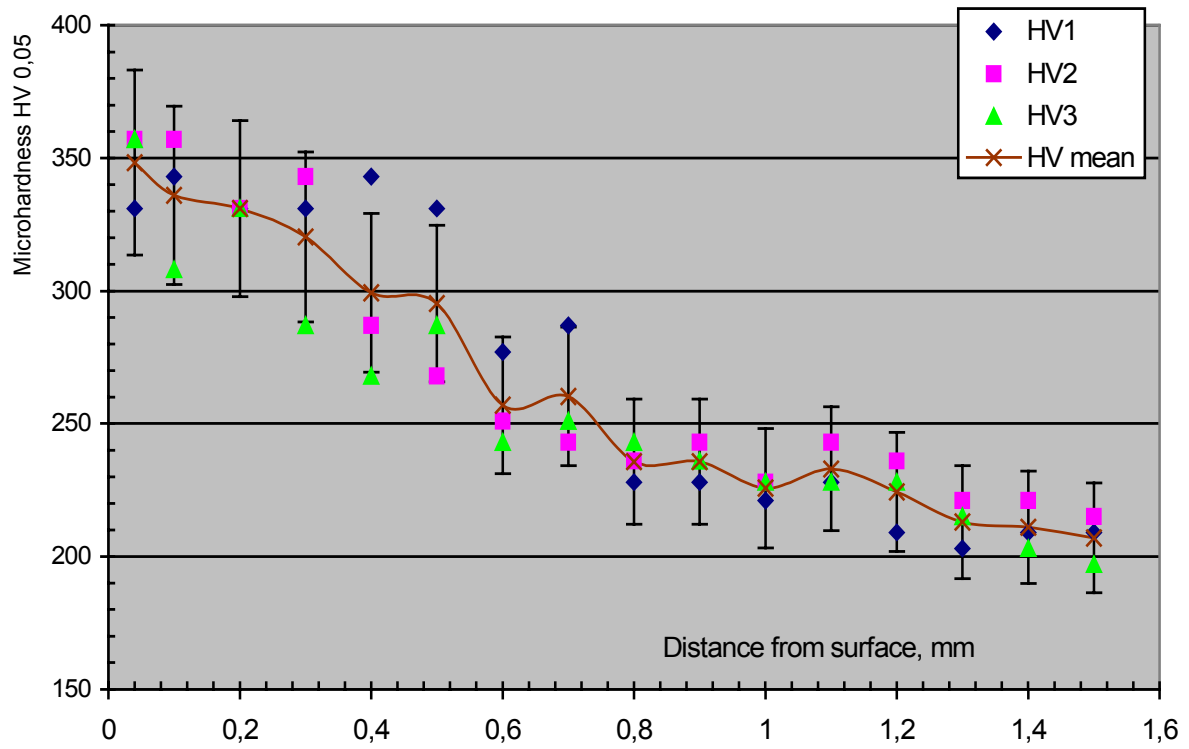

Fig. 24 Specimen No. 1 – base metal treated by manual UIT

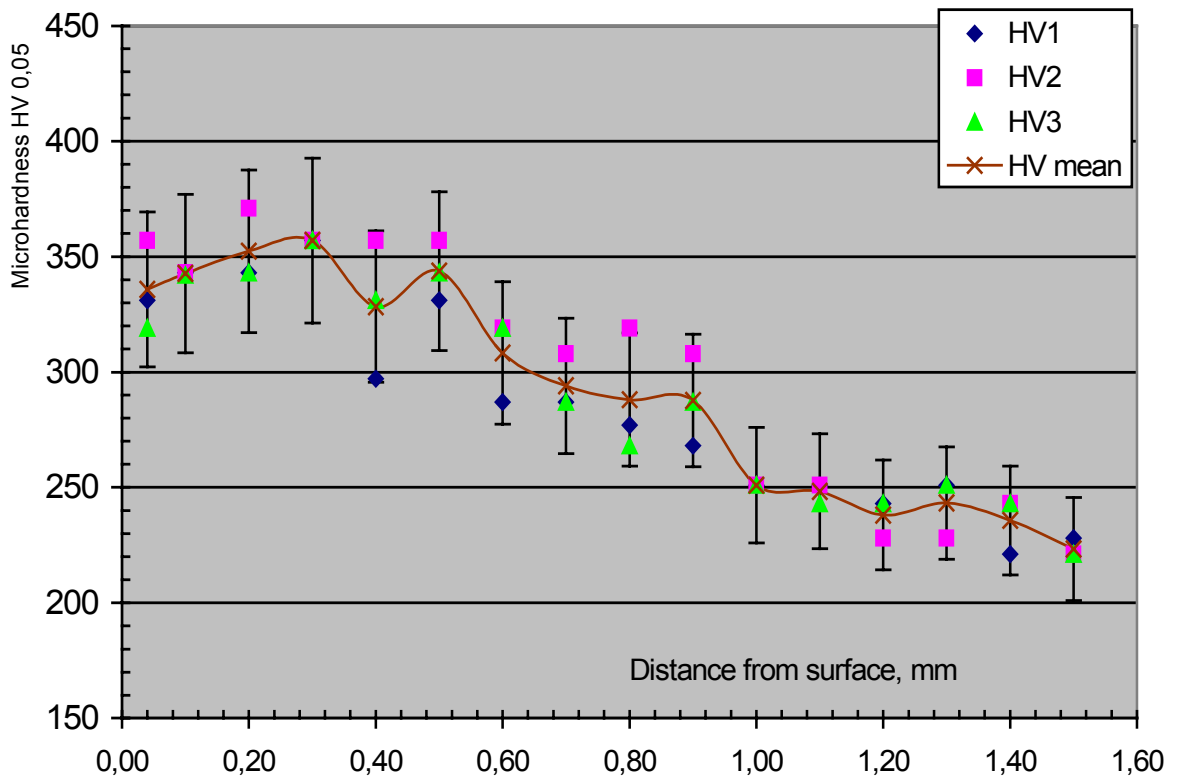

Fig. 25 Specimen No. 2 – deposited metal treated by manual UIT

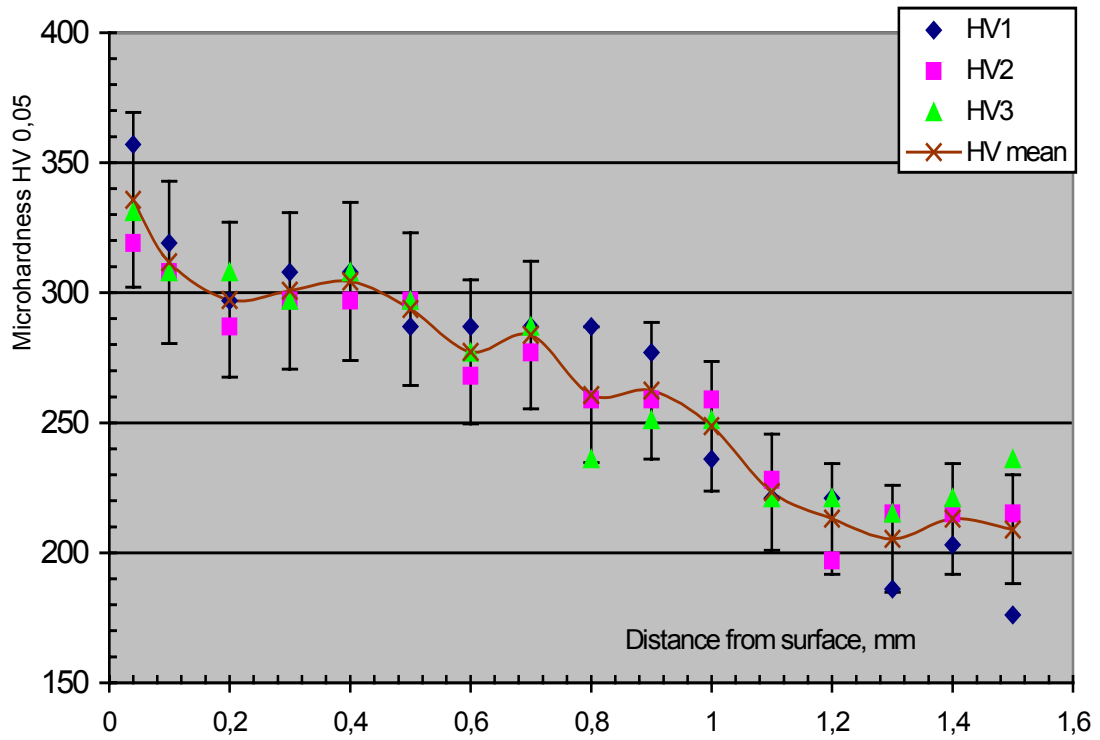

Fig. 26 Specimen No. 3 – deposited metal treated by manual UIT followed by finish with Durex disk

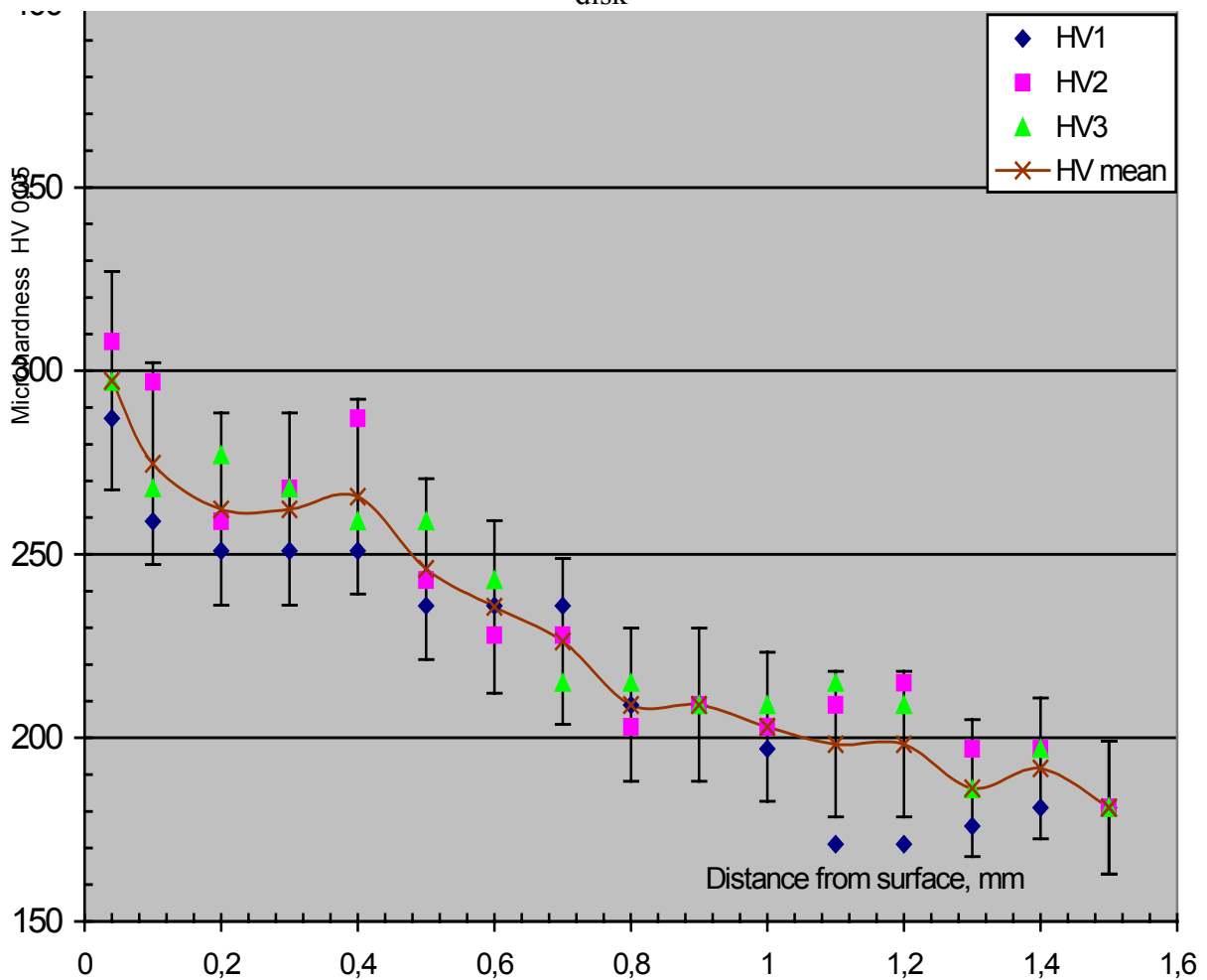

Fig. 27 Specimen No. 4 – base metal treated by manual UIT followed by finish with Durex disk



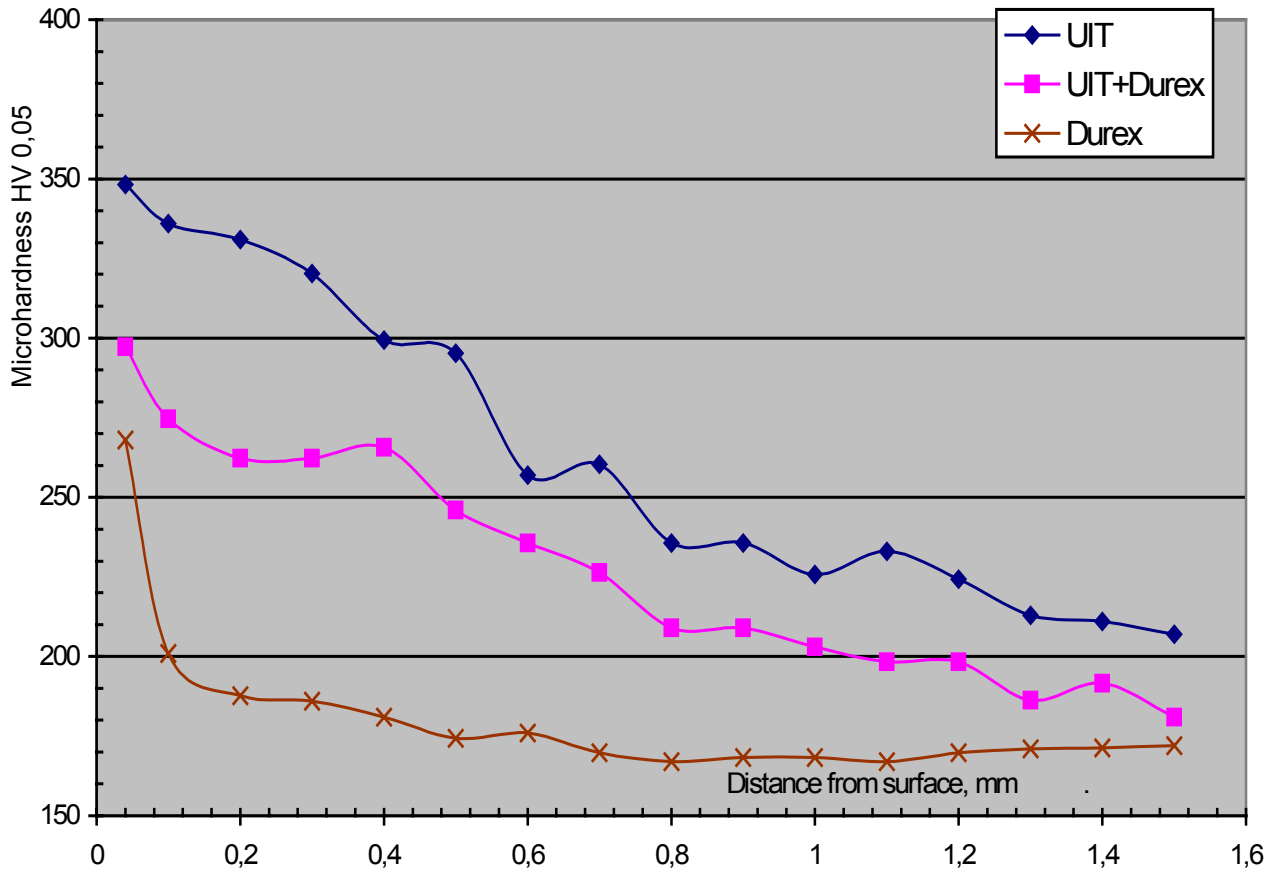

Fig. 28 Specimen No. 5 – base metal finished with Durex disk

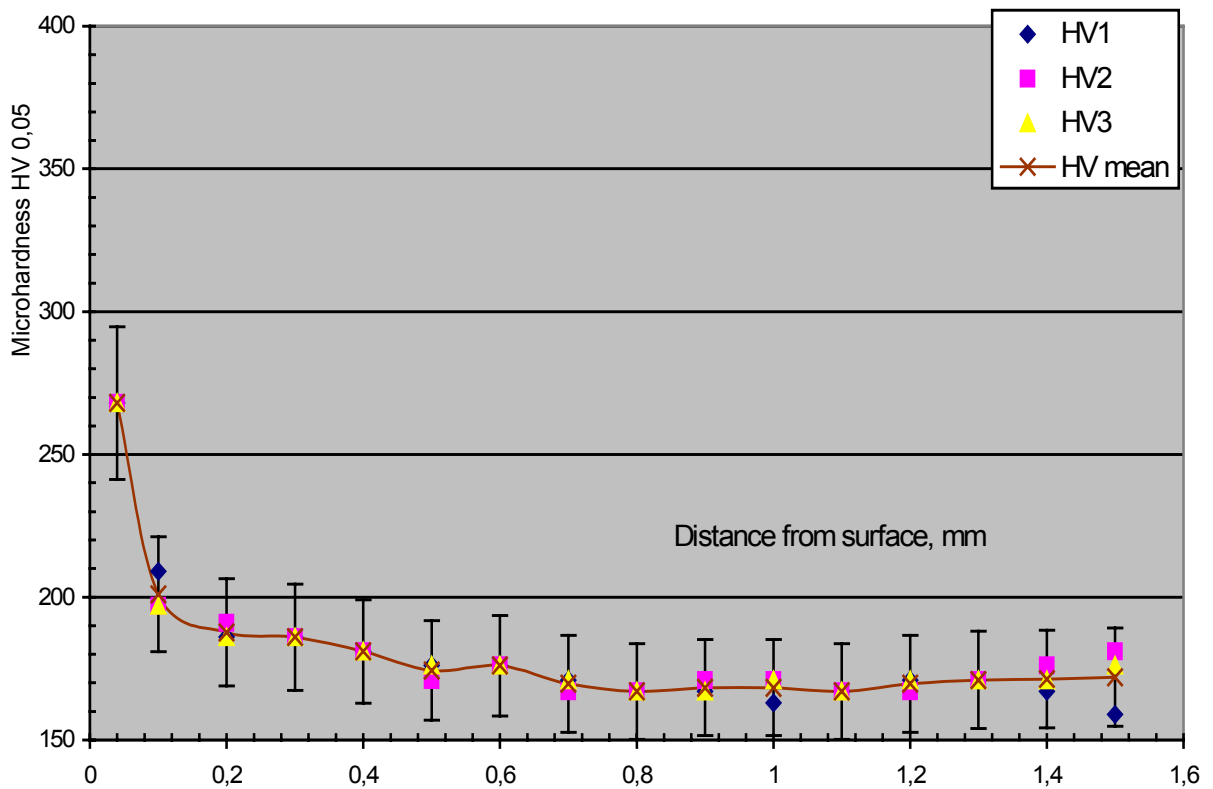

Fig. 29 Microhardness (HV 0,05 mean) of base metal after various treatments

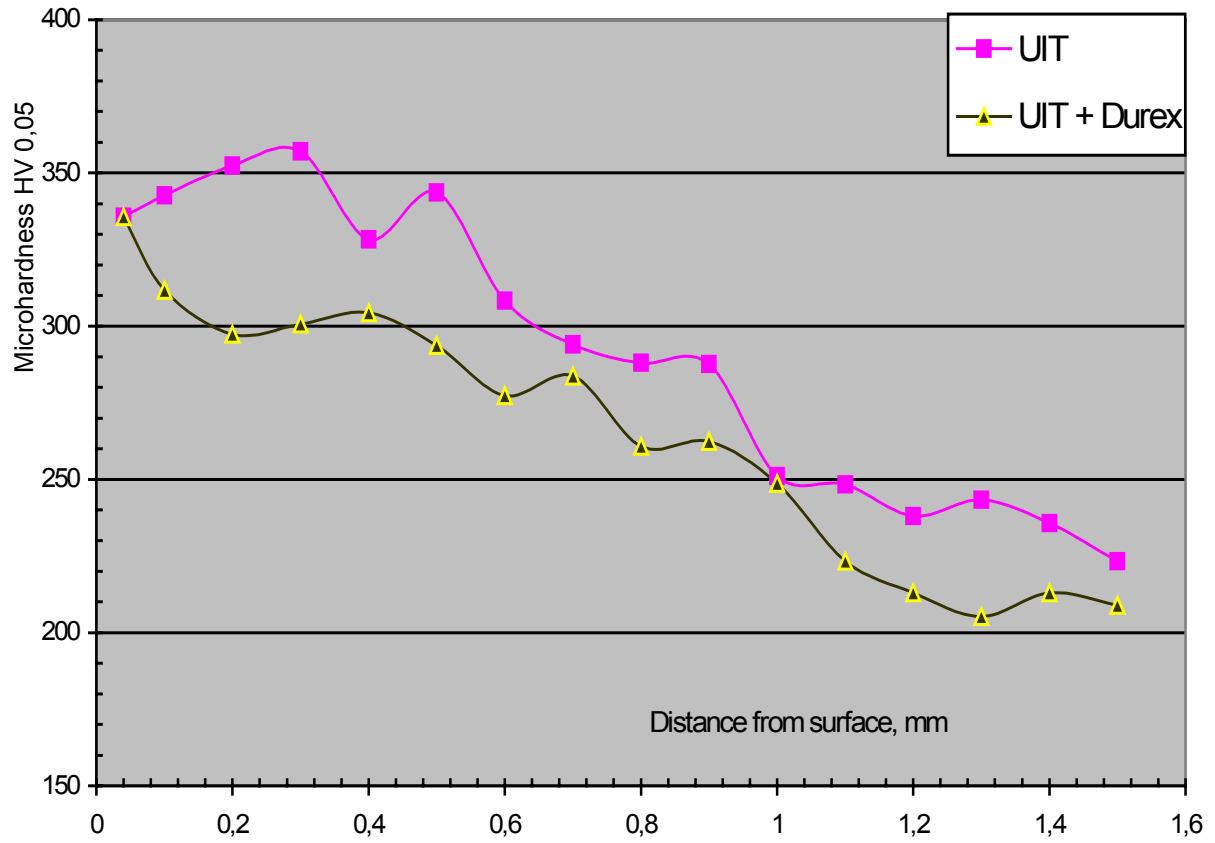

Fig. 30 Microhardness (HV 0,05 mean) of deposited metal after various treatments